

PICHLER

Anleitung / Manual

C-Falke

R/C Motorsegler - Electric Powered Glider

Vorbereitet für den Einbau elektrischer
Störklappen und LED Beleuchtung!
*Factory-prepared for use of electric spoilers (flaps)
and LED lighting!*



ALL Balsa-PLY WOOD CONSTRUCTION.
COVERED WITH ORACOVER*

95% vormontiert
ARF
ALMOST READY TO FLY

Technische Daten *

Spannweite	3060mm
Länge	1600mm
Flächeninhalt	74dm ²
Flächenbelastung	55g/dm ²
Fluggewicht	4000g
R/C	4 -6 Kanal
Servos	5
Motor	PULSAR 40 / Brushless
Regler	PULSAR 50A
Akku	3300-5000mAh / 11,1-14,8V

Specifications *

Wingspan	3060mm
Length	1600mm
Wing Area	74dm ²
Wing loading	55g/dm ²
Flying Weight	4000g
R/C	4 -6 channels
Servos	5
Motor	PULSAR 40 / Brushless
ESC	PULSAR 50A
Akku	3300-5000mAh / 11,1-14,8V

* Änderungen und Irrtümer vorbehalten

* Subject to change without notice

Sonderzubehör für C-Falke / Accessories for C-Falke

Nachstehendes Zubehör wurde von uns ausgiebig erprobt und wird für beste Flugeigenschaften empfohlen. Weitere Informationen und Bestellmöglichkeit unter www.pichler-modellbau.de
*These accessories have been extensively tested and are recommended for best flying performance.
 For more information please visit www.pichler-modellbau.de*



C5067
PULSAR 40 Brushless Motor



C6130
PULSAR 50 Brushless Regler
PULSAR 50 Brushless ESC



C6750
Akku LEMONRC 5000-14.8V
Battery LEMONRC 5000-14.8V



C5400
Störklappen elektrisch (2)
Electric Spoilers (2)



3 x #C1689 Servo DS6020 # C5753
2 x #C5638 Servo DS3012 MG PI-CON Propeller 12 x 6



C4738
Akku Klettband
Battery Straps

C6857
LED Modell Beleuchtungsset / LED light set



Geheimtipp! Must Have !

C6910 Schutztaschenset Tragflächen und Rumpf für C-Falke
Wing Bag Set Wings and Fuselage for C-Falke

Dieses ferngesteuerte R/C Flugmodell ist für Anfänger nicht geeignet sondern richtet sich an fortgeschrittene Modellbauer. Trotz sehr hoher Vorfertigung erfordern die Endmontage und der Betrieb des Modells etwas Übung sowie grundlegende Erfahrungen. Wenn Sie unerfahren sind, bitten Sie einen Modellbaukollegen um Hilfe oder fragen Ihren Modellbau-Fachhändler vor Ort. Bevor Sie mit dem Zusammenbau beginnen, prüfen Sie den Inhalt auf Vollständigkeit, Passgenauigkeit bzw. eventuelle Mängel. Für den Zusammenbau benötigen Sie das übliche Werkzeug sowie Klebstoffe wie Sekundenkleber und 5-Minuten Epoxy. Der Lieferumfang kann ggf. abweichen. Das Modell wurde von erfahrenen Mitarbeitern weitgehend in Handarbeit gefertigt und selbstverständlich vor dem Versand im Werk sorgfältig geprüft. Trotzdem bitten wir Sie zu beachten: Wir entwickeln und fertigen unsere Modelle aus der Praxis für die Praxis d.h. zum Fliegen, und nicht etwa für das Museum. Deshalb gilt: Kleine Unregelmäßigkeiten am Modell sind normal und berechtigen nicht zur Reklamation. Ein gewisses Maß an Nacharbeit kann erforderlich sein und ist dem Kunden (= fortgeschrittener Modellbauer) zuzumuten. Das Modell wurde werksseitig mit hochwertiger Polyester Bügelfolie falten- und blasenfrei bespannt. Aufgrund von Temperaturschwankungen während Transport und Lagerung kann es zu mehr oder weniger starker Falten- und Blasenbildung kommen. Dies ist normal und kein Reklamationsgrund. Mit einem Heißluftgebläse (Fön) kann die Folie unter vorsichtiger Wärmeeinwirkung wieder gespannt werden. Produktionsbedingt können unter weißer Bügelfolie hellbraune Schlieren zu sehen sein. Auch dies ist produktionsbedingt und stellt ebenfalls keinen Reklamationsgrund dar. Vielen Dank für Ihr Verständnis.

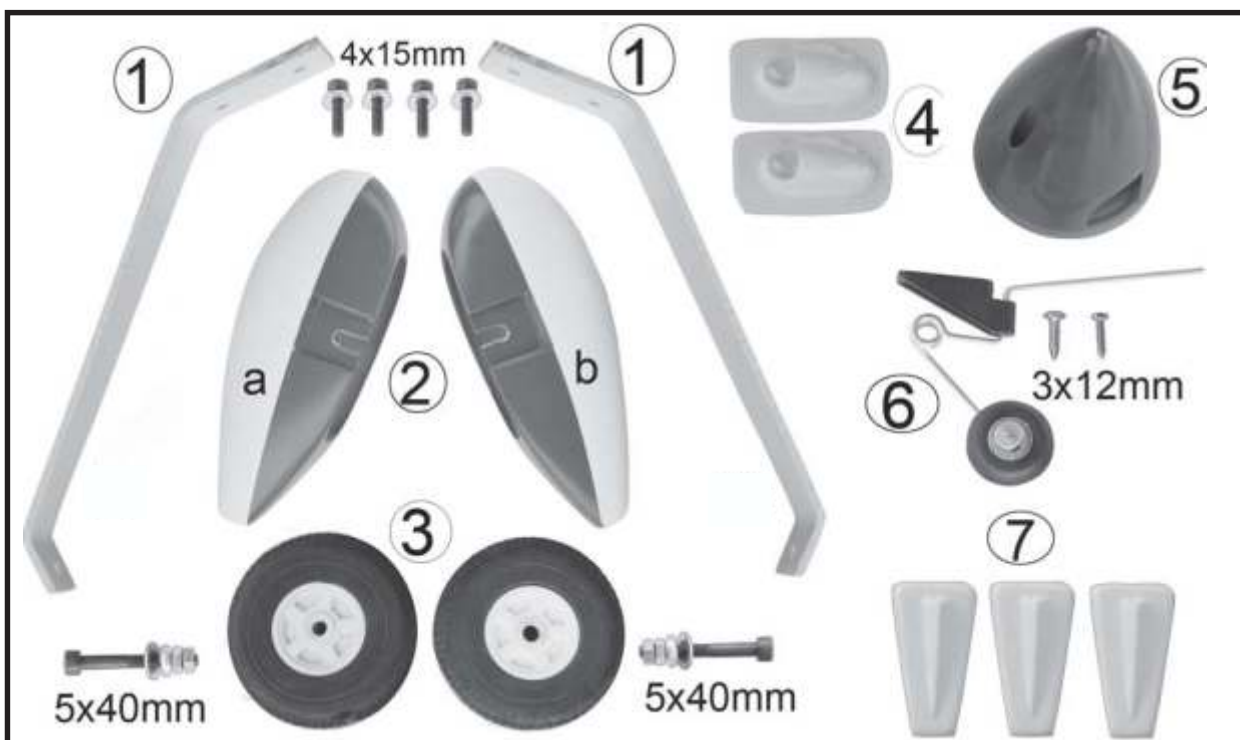
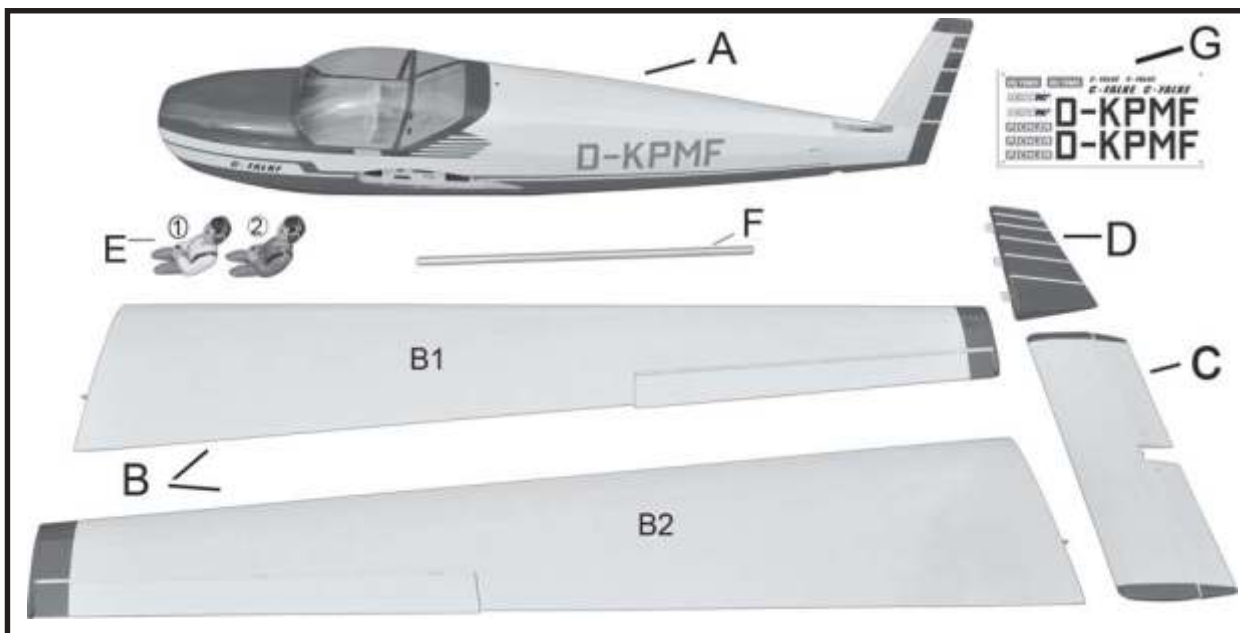

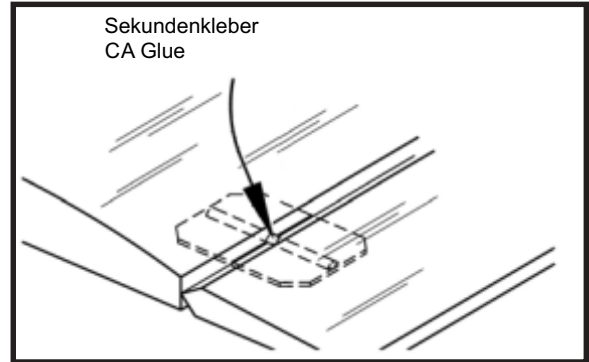
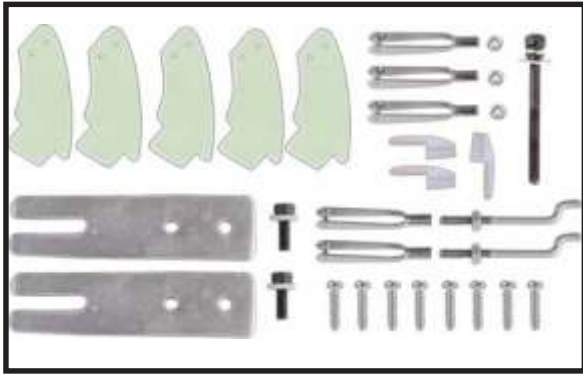

Querruder / Aileron

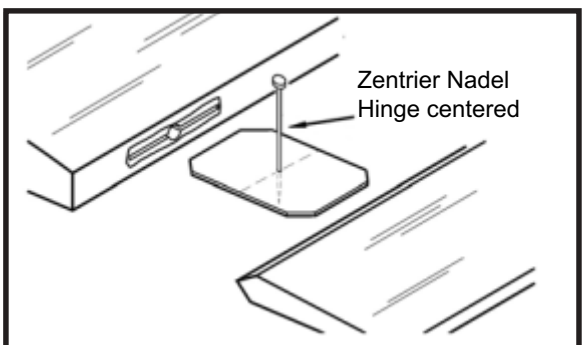
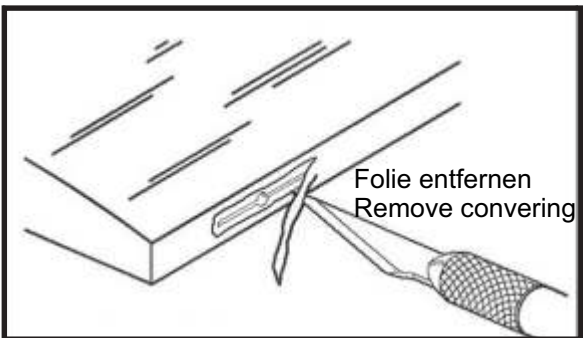
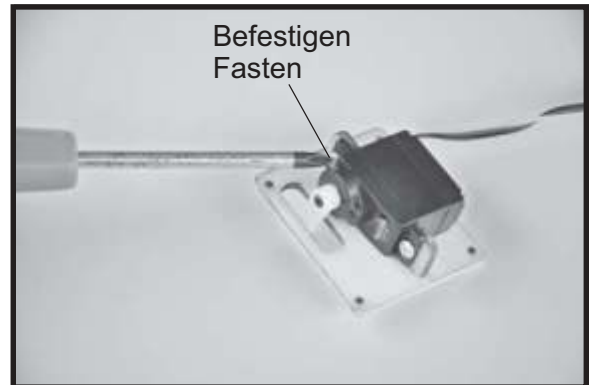
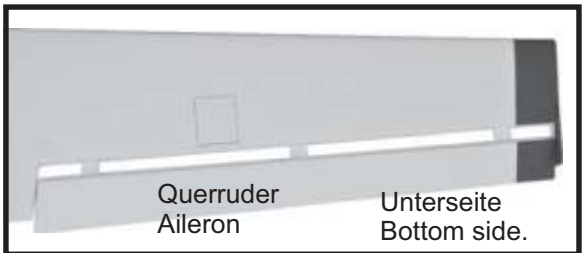
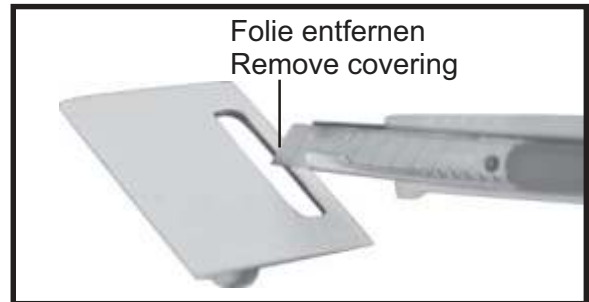
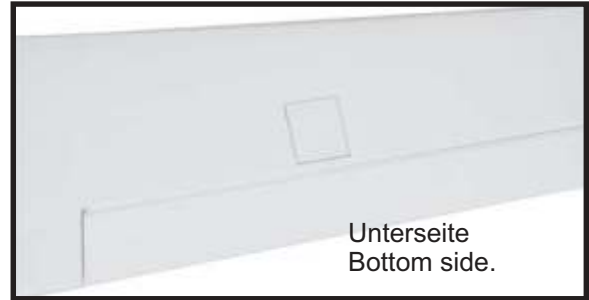

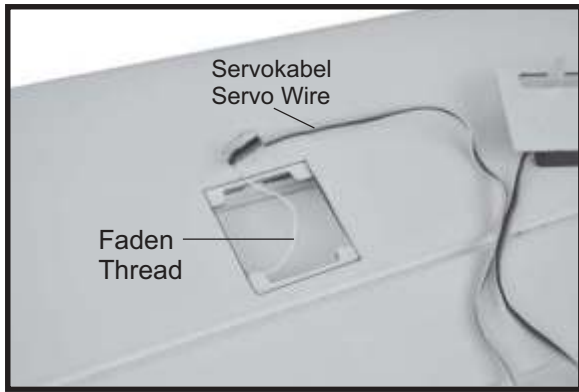

Querruder Anlenkung / Aileron Linkage

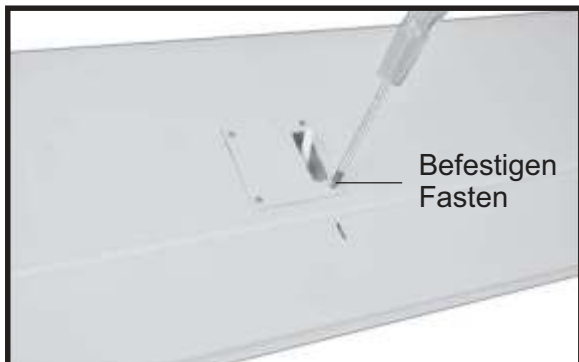
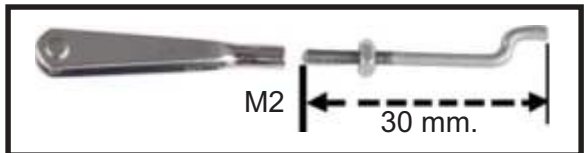
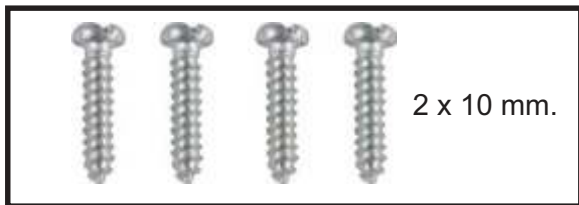
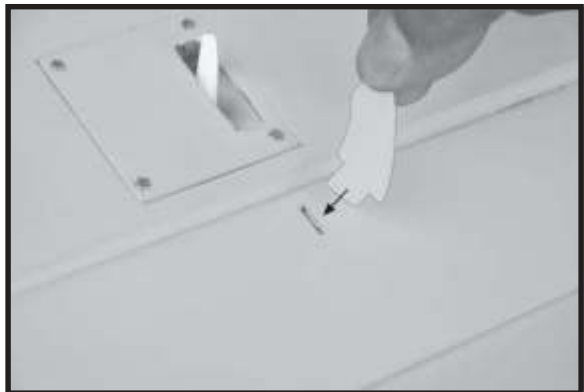
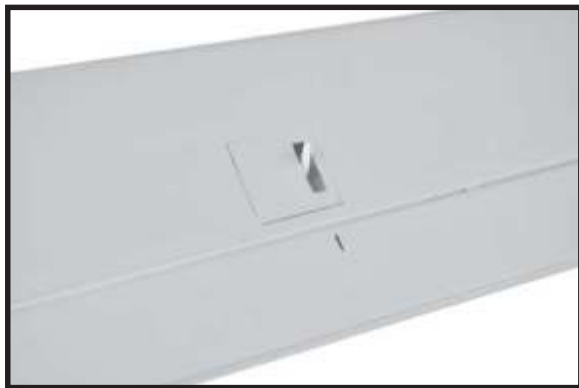
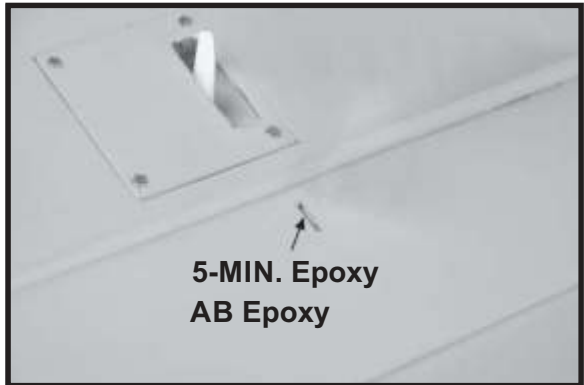
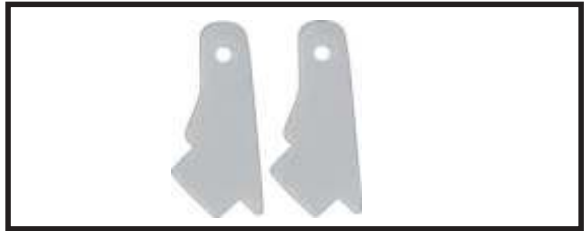

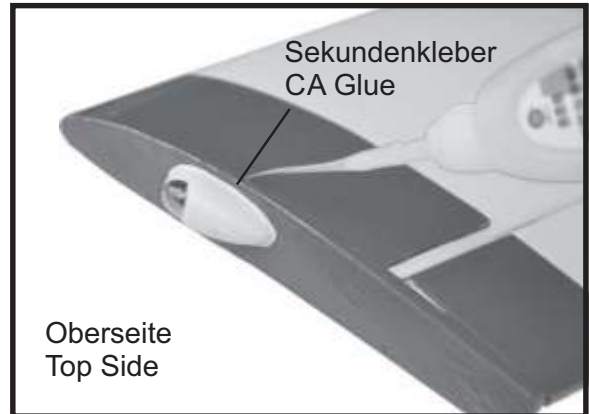
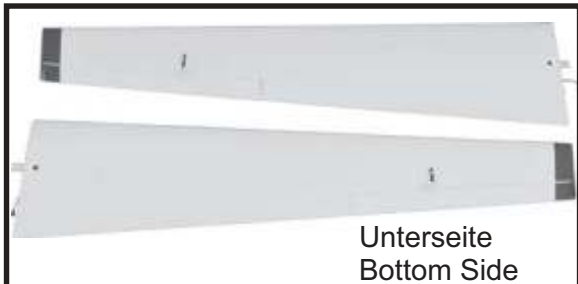
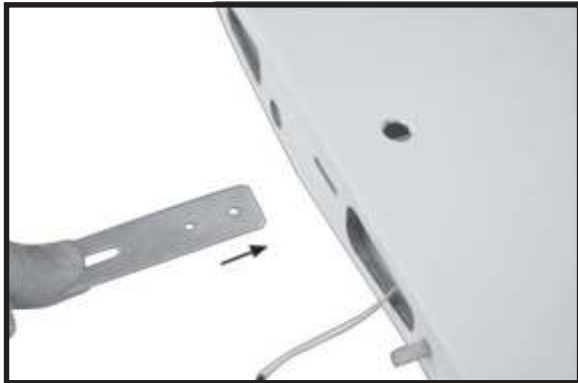
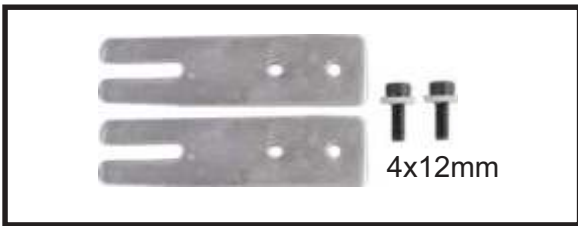

Einbau Störklappen / Electric Spoilers

(Seperat erhältlich / Available seperately)





Motoreinbau / Motor installation



Spinner

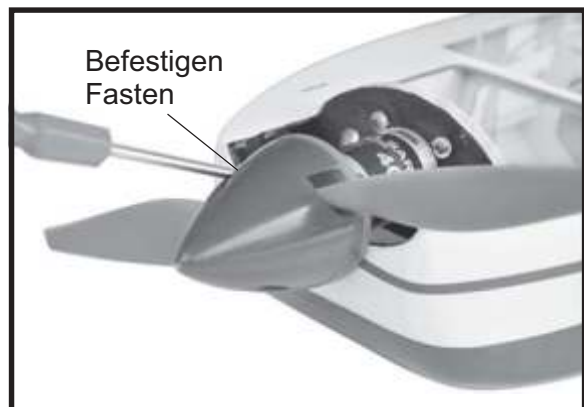

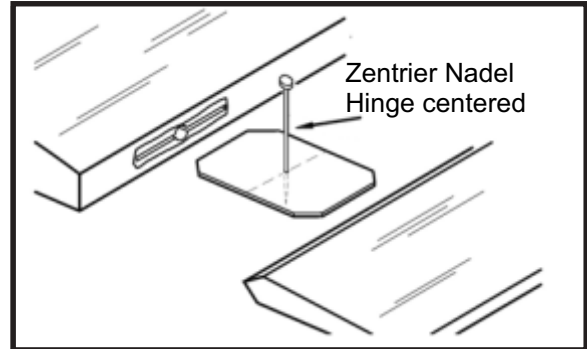

Servo Installation

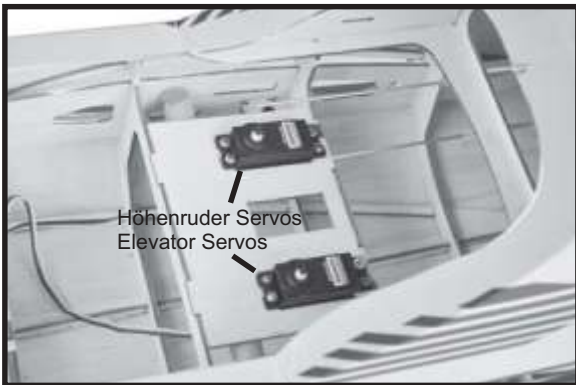
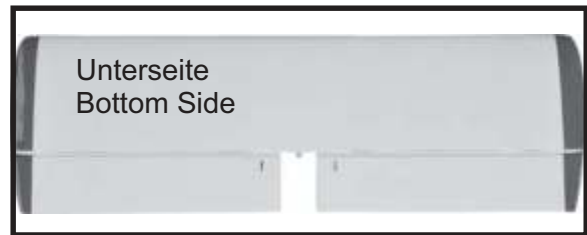
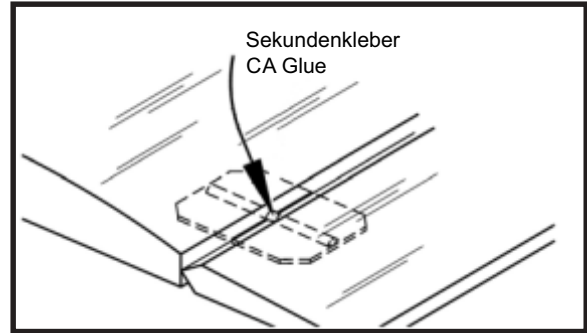

Höhenruderanlenkung / Elevator linkage

Höhenruder / Horizontal stabilizer

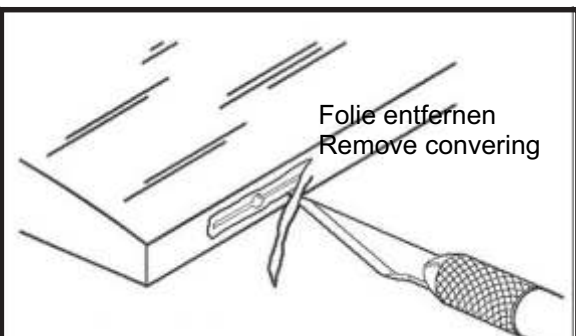
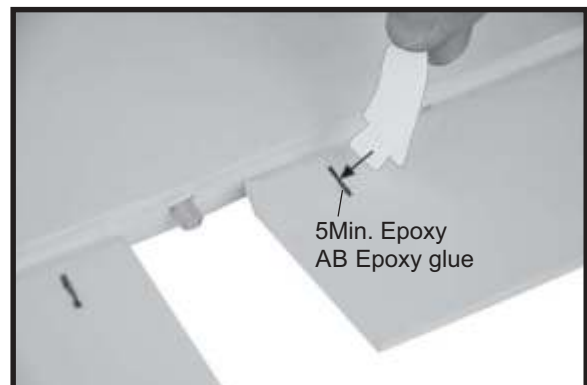
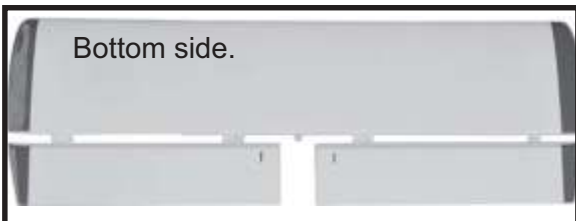
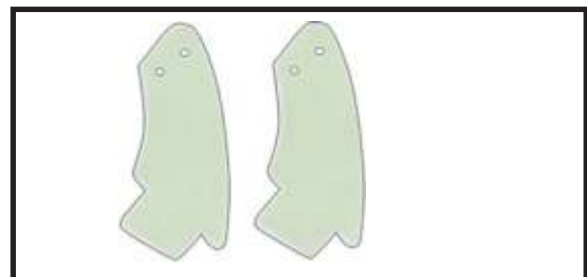

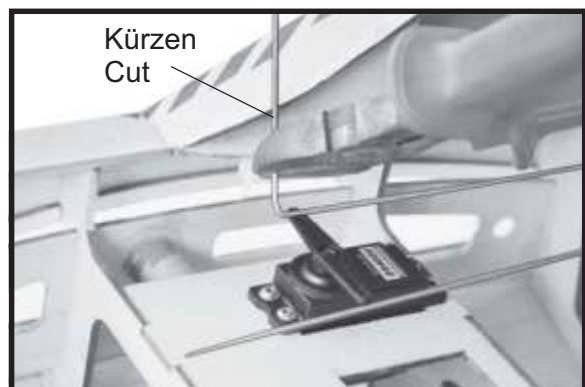
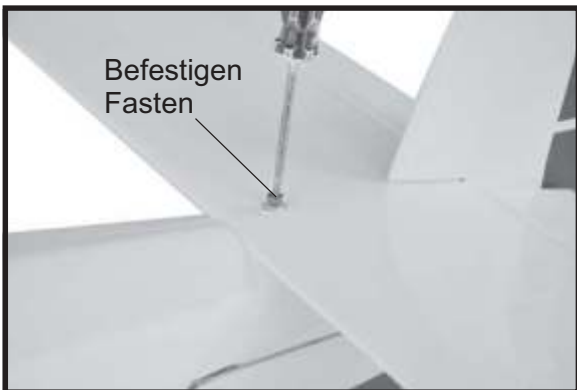
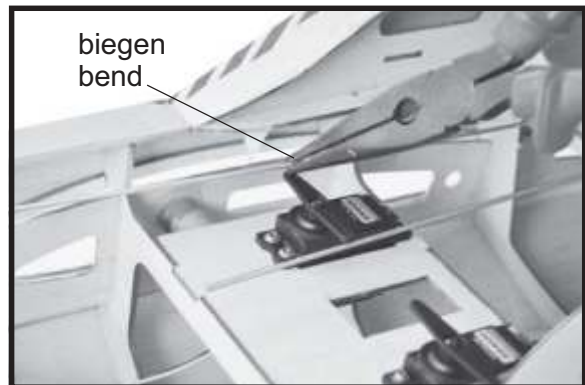
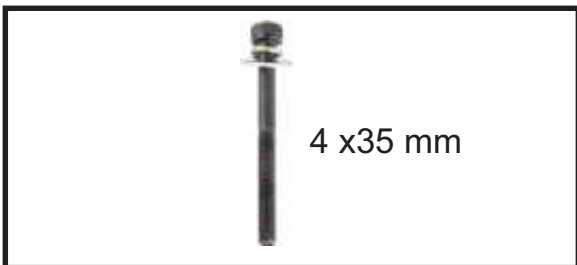
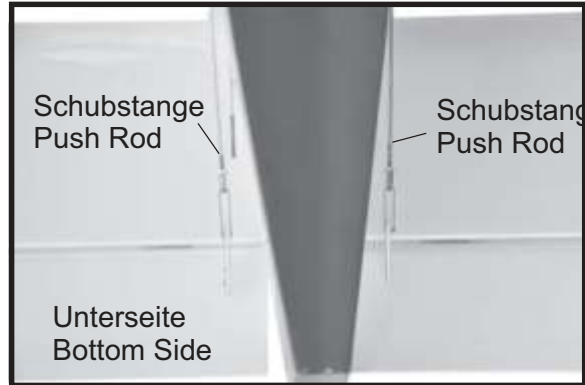
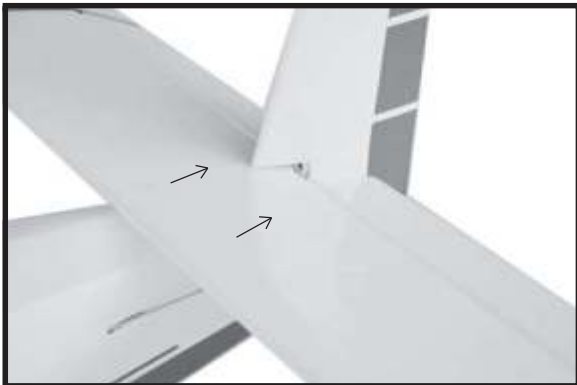
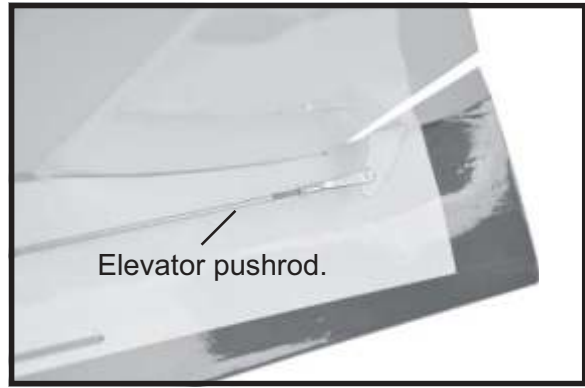
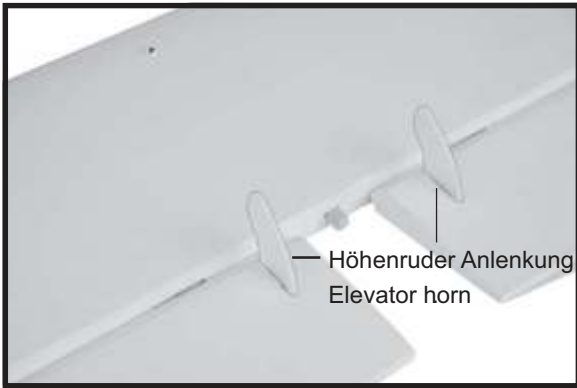

Schubstangen / Push Rods

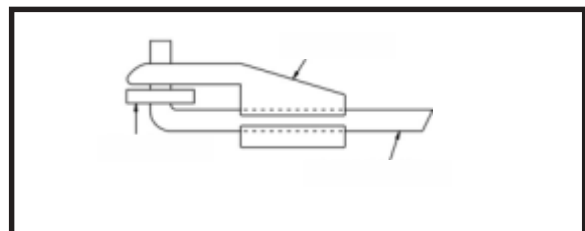

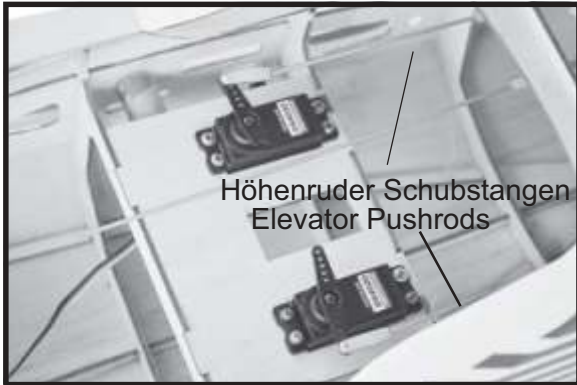

Seitenruder Anlenkung / Rudder linkage

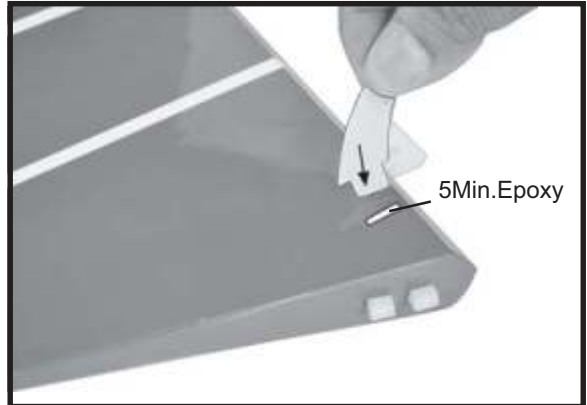

Seitenruder Servo / Rudder Servo

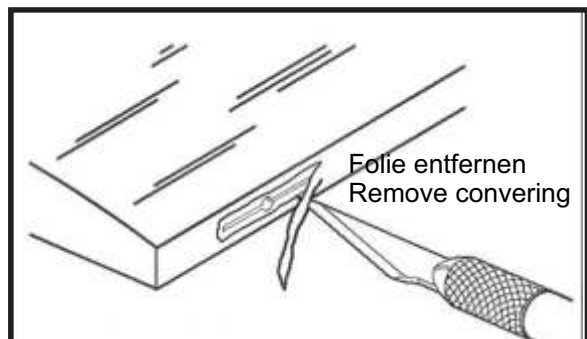
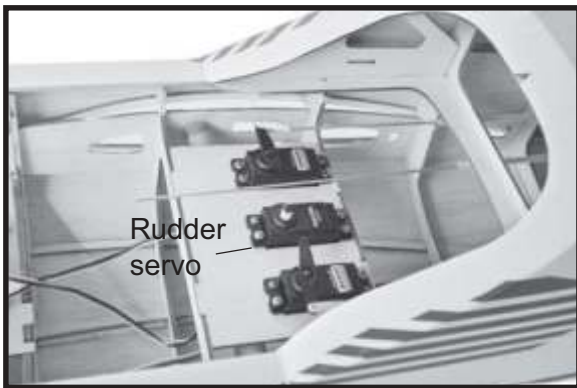

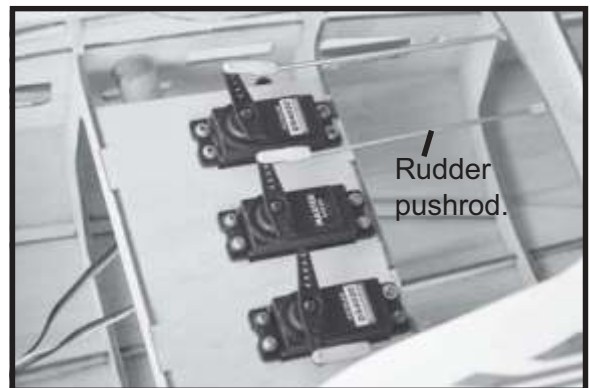
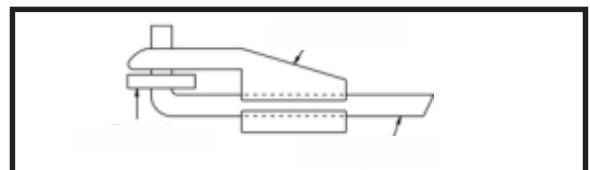
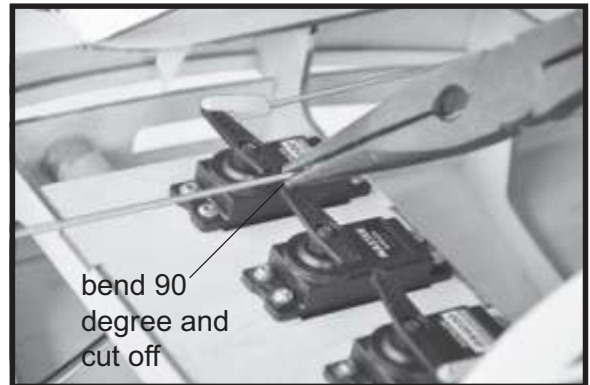
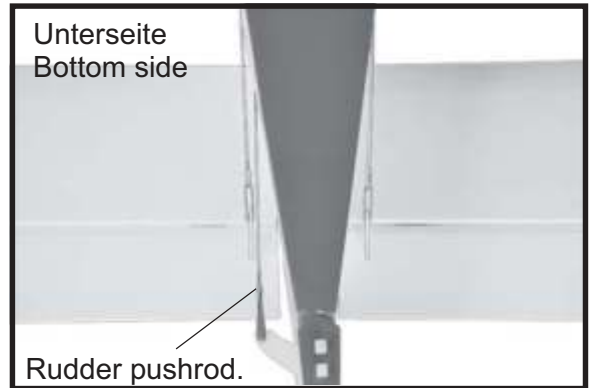
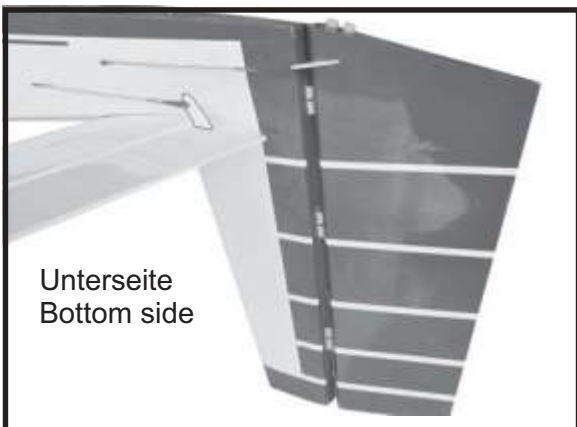
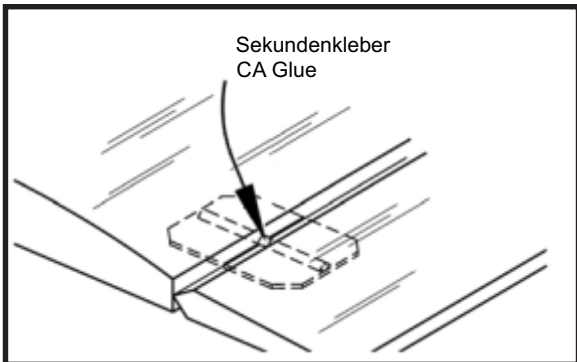
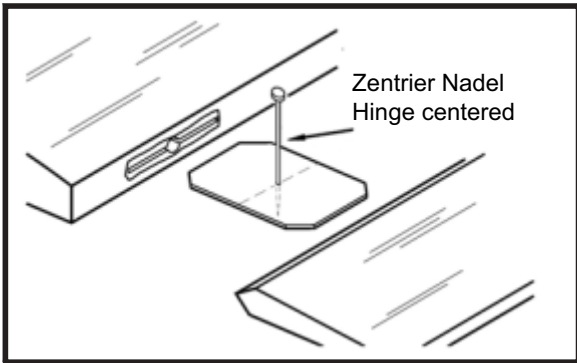

Schubstange / Push Rod

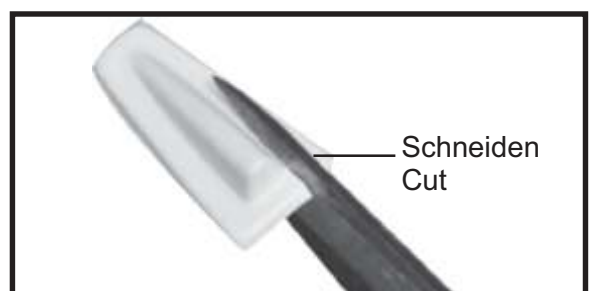
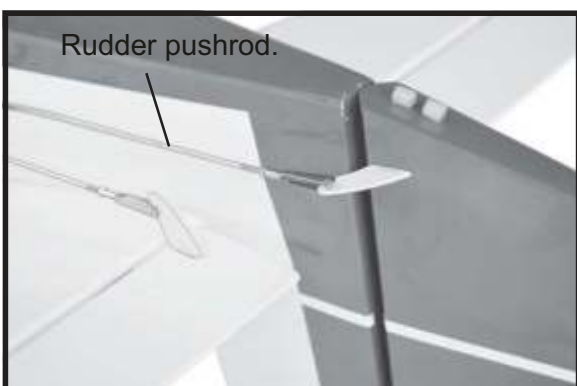

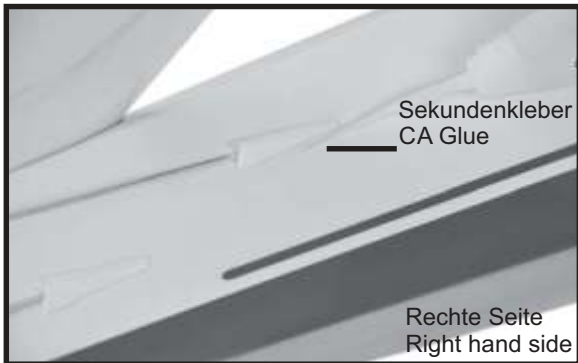

Hauptfahrwerk / Main Gear

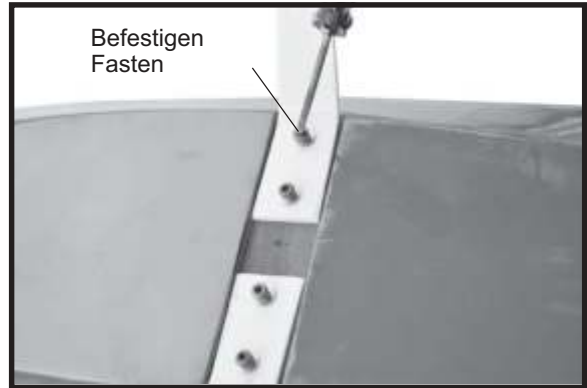
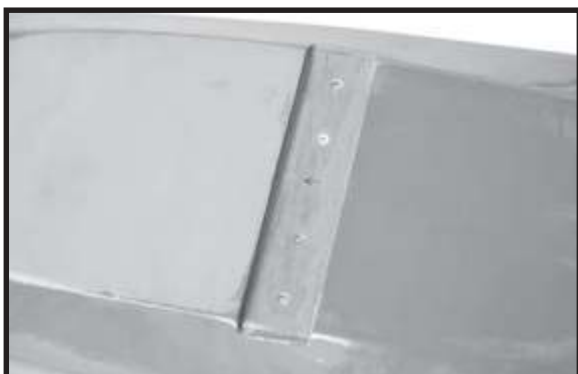
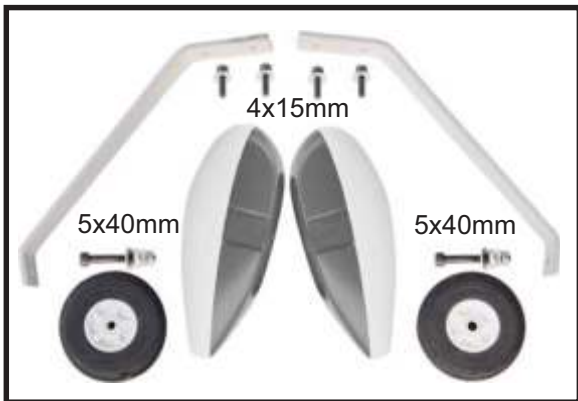



Repeat the process for the other wheel.



Spornfahrwerk / Tail Gear

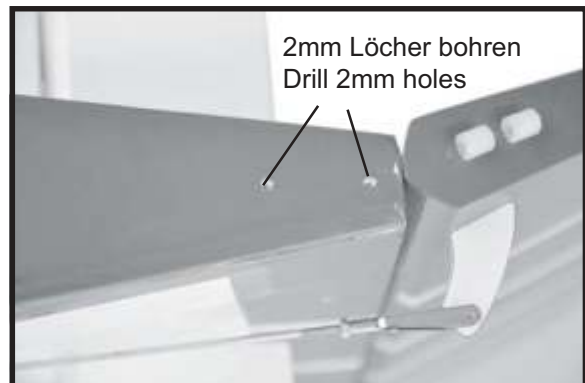

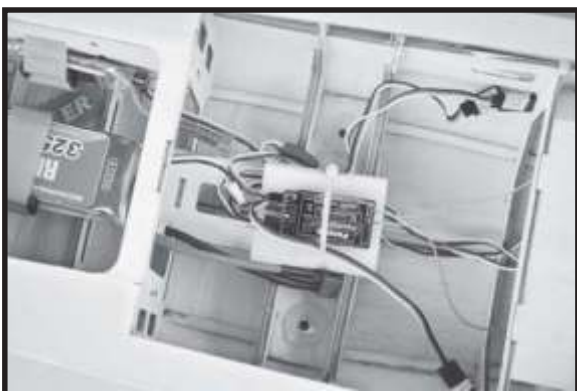
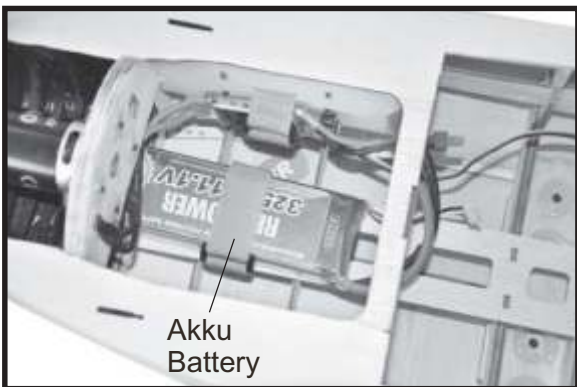
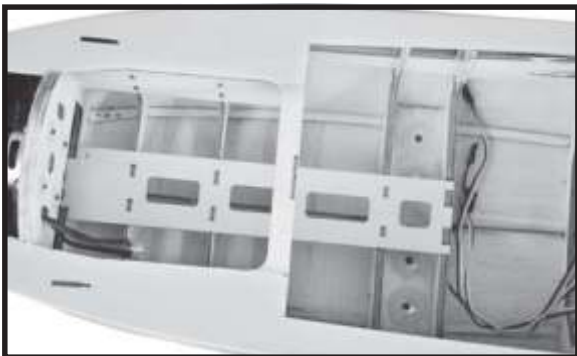
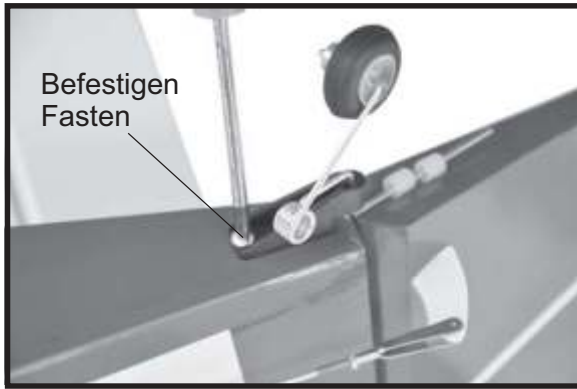

Tragfläche / Main Wing

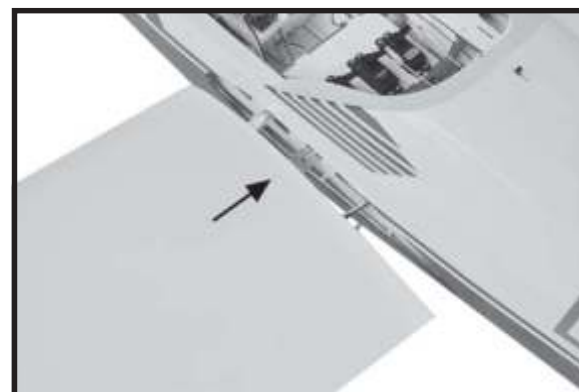
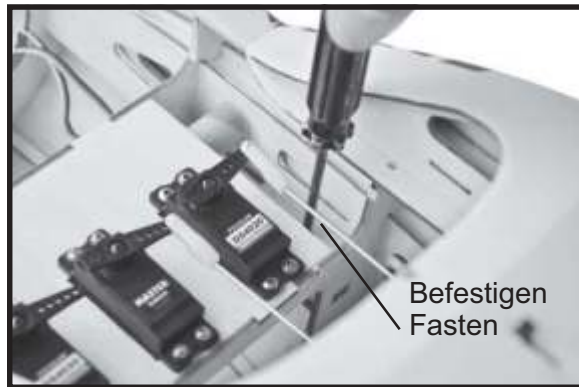
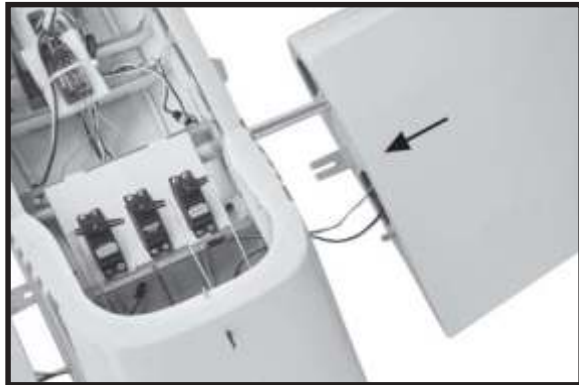
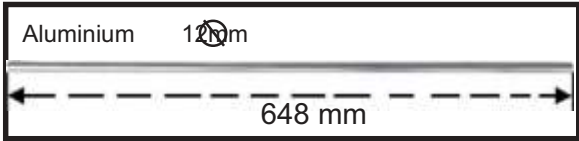

Cockpit

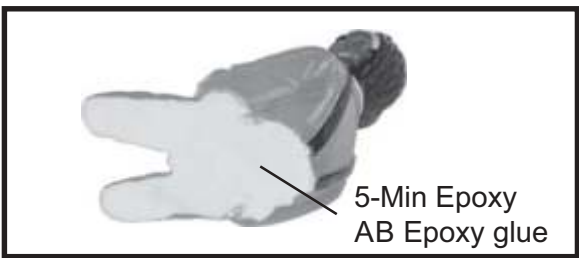
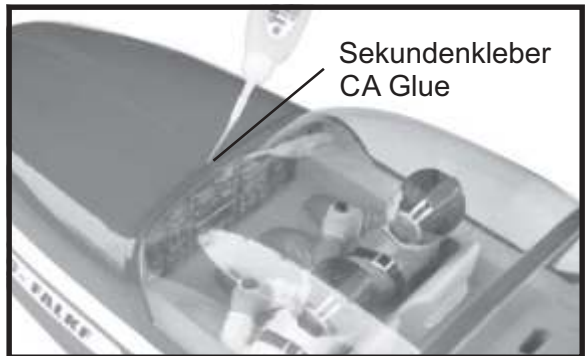
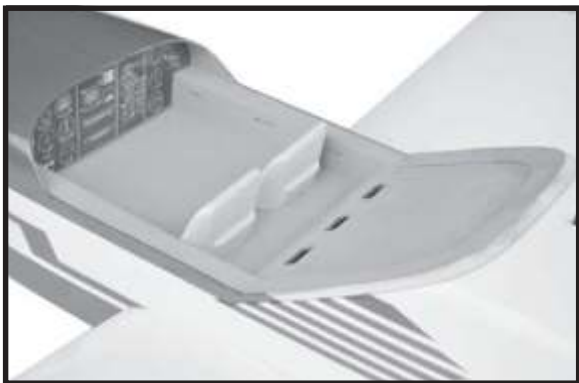

Wichtige Hinweise vor dem Flug

Sparen Sie nicht am Zubehör sondern folgen Sie unseren Empfehlungen damit Sie höchstmöglichen Flugspaß aus Ihrem C-Falken herausholen können. Wir haben uns sehr viel Mühe damit gemacht, für Sie die richtigen Zubehörkomponenten zu „erfliegen“.

Stellgenaue Digitalservos wie unser DS6020 wirken sich absolut positiv auf das Flugverhalten aus. Billigservos sollten ein absolutes Tabu sein.

Sie können das Modell mit einem 11,1V oder 14,8V LiPo Akku fliegen. Je kleiner der Akku, umso mehr Ballast werden Sie vorne benötigen, um den Schwerpunkt zu erreichen. LEMONRC oder RED POWER LiPo Akkus sind in jeder Hinsicht die beste Wahl. Obwohl wir einen starrer Propeller für dieses Modell vorsehen, werden Sie von den ausgezeichneten Gleit- und Thermikeigenschaften begeistert sein.

Die elektrischen Störklappen ermöglichen Ihnen punktgenaue Landungen und sorgen dafür dass Sie das Modell auch bei Thermik wieder „runter“ bekommen. Den letzten Schliff erhält der C-Falke mit dem LED Beleuchtungssatz der als Sonderzubehör lieferbar ist.

Und mit dem paßgenauen DeLuxe Schutzeset ist Ihr Modell während dem Transport oder zur Aufbewahrung bestens geschützt.

Schwerpunkt / Center of Gravity

Der ideale Schwerpunkt befindet sich 55mm von der Nasenleiste aus nach hinten gemessen, **und zwar von dem Punkt aus gemessen, an dem die Tragfläche auf den Rumpf trifft!**

The ideal Center of Gravity (CG) is located 55mm behind the leading edge **where the fuselage meets the wing panel!**

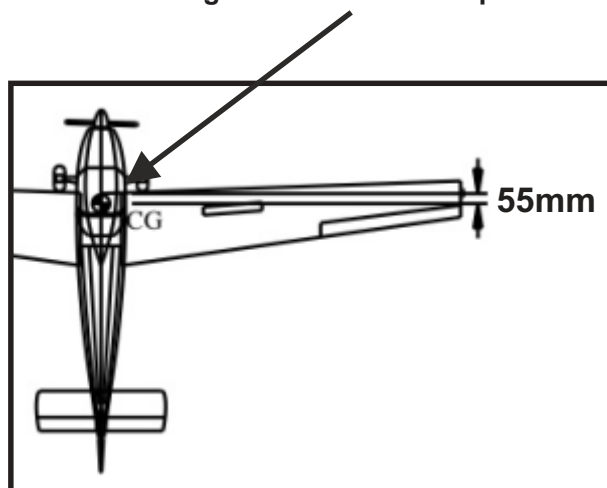

Ruderausschläge / Control Throws

Querruder Aileron		25 mm
		20 mm
Seitenruder Rudder		40 mm
		40 mm
Höhenruder Elevator		20 mm
		20 mm