

# Cessna L-19 Bird Dog

## Build instructions

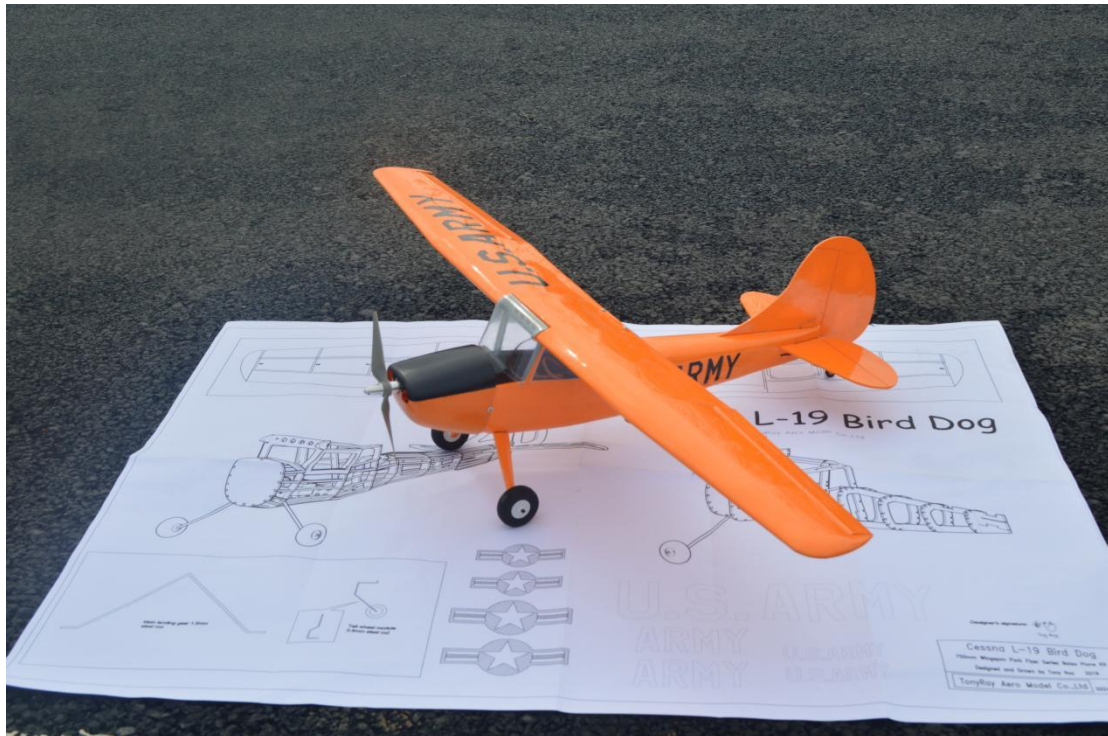

<b>Specifications</b>	
Wing Span	29.5 in / 75cm
Wing Area	7.15 sq dm
Flying weight	150g-180g
Fuselage length	50cm
Scale	1 / 15

<b>Requires</b>
RC transmitter with at least 4 channels
Aileron: 2.5g servos(ES9251)*2
Rudder&Elevator: 2.5g servos(ES9251)*2
Motor system: EPS1404 7800KV

# **BEFORE YOU BEGIN**

## **Attentions and Tips**

1. Read through the manual before you begin, so you will have an overall idea of what to do.
2. Check all parts. If you find any serious defects or missing parts, please contact your local dealer.
3. Please build your kit in strict accordance with the sequence of the user manual.
4. Pre-Sanding: Before removing any parts from the laser-cut plywood sheet, use a sanding block loaded with 250 - 400 grit sandpaper and lightly sand the back side of the sheet. Which can significantly reduce burn marks of the wood and make the parts match better
5. Before building the model part on drawings, It is recommended to cover a layer of kitchen cling film (polyethylene film) on the drawing. This way can prevent parts from sticking to the drawing and causing damage.
6. Parts Assembly: This product's tabs and notches interlock like a 3D puzzle. We strongly suggest that when fitting parts, you "dry fit" (use no glue) the parts together first. It is advised to work 1 - 2 steps ahead in the instructions, using this dry-fit technique. This allows the opportunity to inspect the fit and location of assembled components, and shows the benefits of our construction technique. As each successive part is added, it contributes to pulling the entire assembly square. Once you arrive at the end of a major assembly sequence, square your work on a flat work surface, and bond the dry-fit joints with glue. Using the dry-fit process, you'll be able to recover from a minor build mistake, and will ultimately end up with a square and true assembly.
7. This is a precision laser-cut kit. Our lasers cut to within 0.2mm in accuracy. Yet the wood stock supplied to us by the mill may vary in thickness by up to 0.2-0.3mm. This variance in the wood stock can cause some tabs and notches to fit very tightly. With this in mind, consider lightly sanding or lightly pinching a tight-fitting tab, rather than forcing the parts together. You may break some parts in assembly, but please don't worry, after the final covering work, it will not affect the strength and appearance of your model. You will end up with a circle and true airframe.

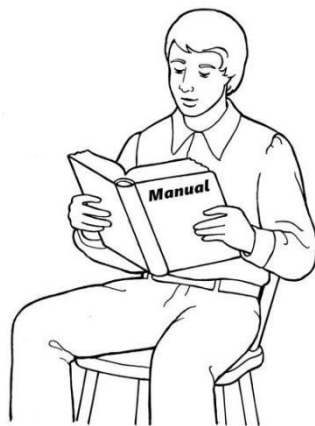

# KIT INVENTORY

<b>Sheet Wood Inventory</b>	
Item:	Quantity
2.0mm Plywood	1
2.0mm Balsa	2
2.0mm Paulownia	1
1.0mm Balsa	4
1.0mm Plywood	1

<b>Hardware*</b>	
<i>1. Hardware in plastic bag</i>	
Laser cut Pvc sheet	1
Paper hinge	2
PU wheels	2
pin	4
Steel rod (diameter:1.5mm)	25 cm
Steel rod (diameter: 0.8mm)	10 cm
Carbon rod (diameter: 1mm)	2
M2 Four Claws Nut	2
M2*8 Screws (Spacer Version)	20
M2*5 Screws (Spacer Version)	3
M1*3 Screws	10
M1.7*6 Screws (Spacer Version)	15
Heat shrinkable tube	4
<i>2. Vacuum Formed Canopy</i>	
Canopy	2



**Note:**

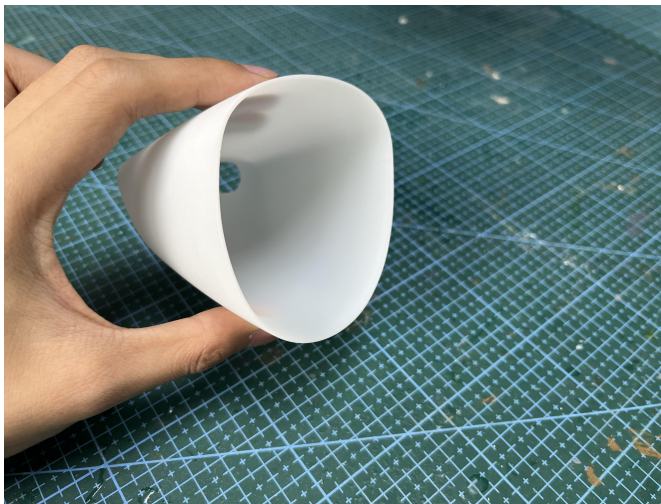
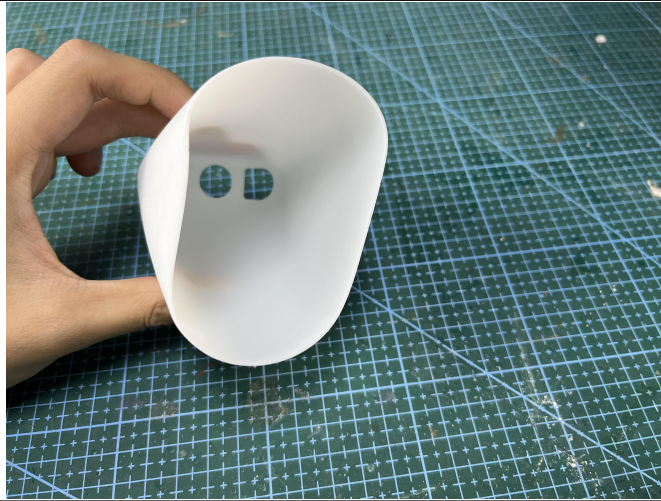

Due to the photosensitive resin molding process, the fairing may bend, which is normal. If you need to correct it, use a heat gun to carefully heat it, or soak it in hot water, and then adjust its shape.



# ASSEMBLY-Fuselage

Step1

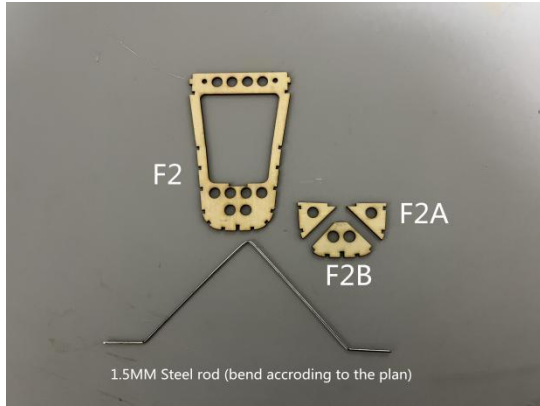

Step2

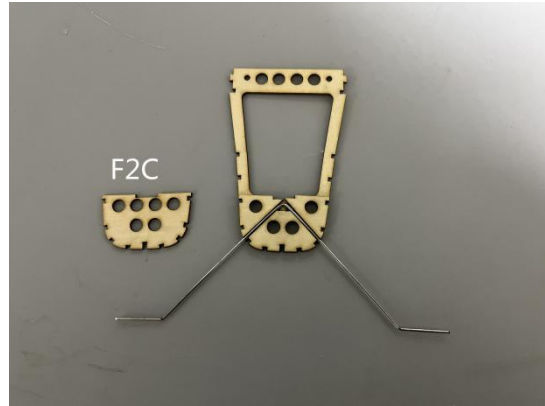

Step3

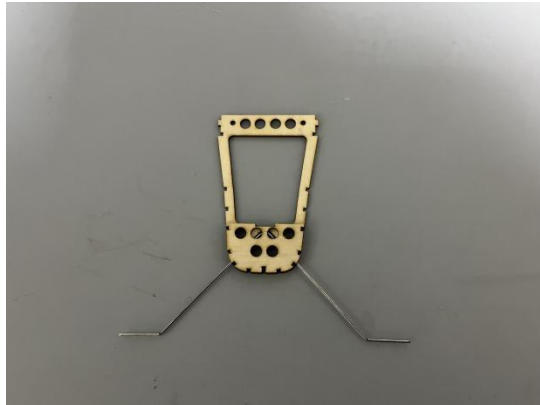

Step4

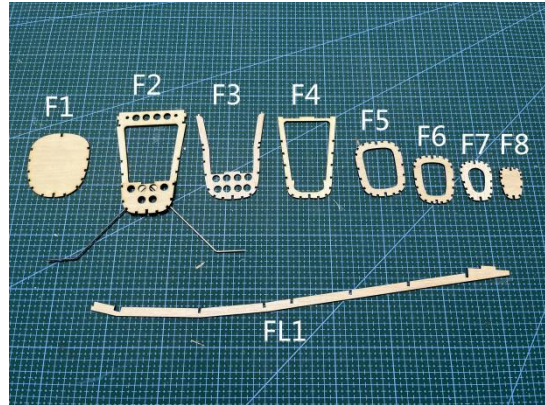

Step5

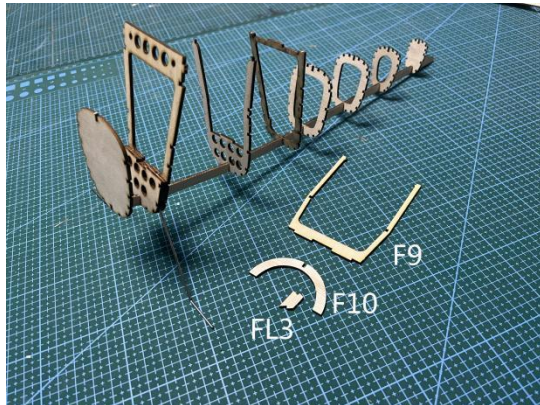

Step6

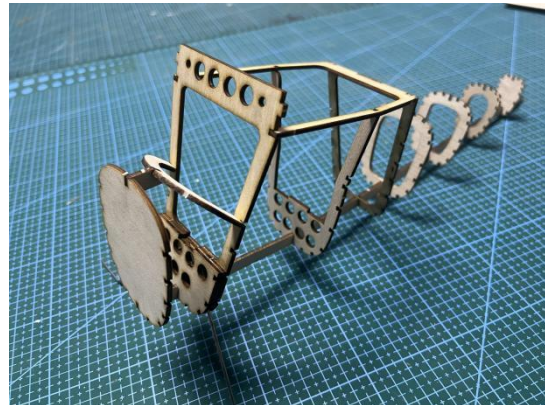

Step7

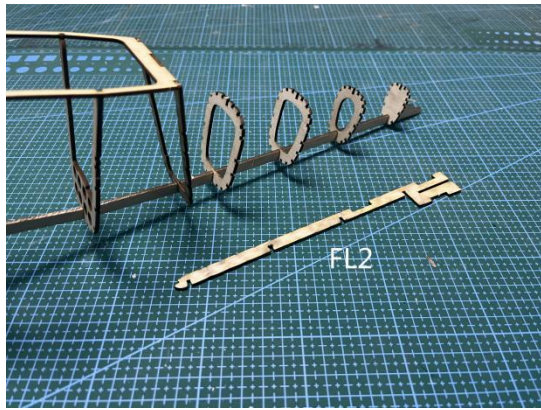

Step8

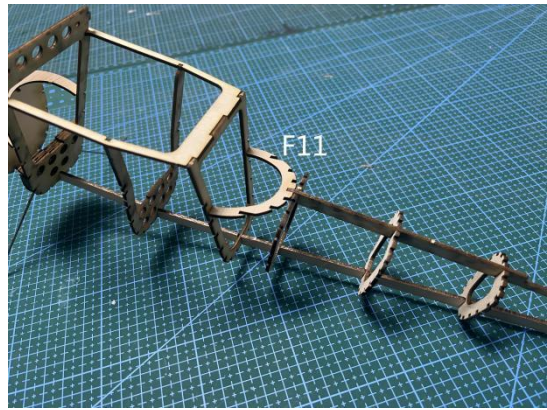

Step9

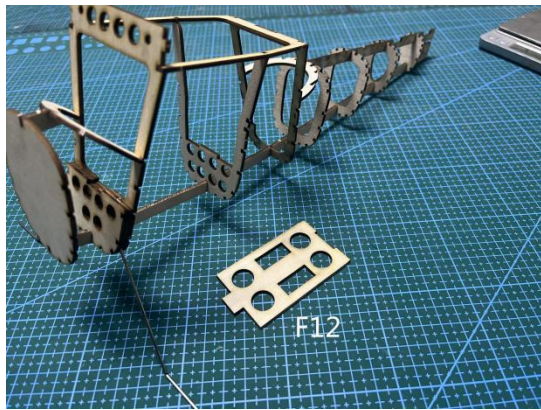

Step10

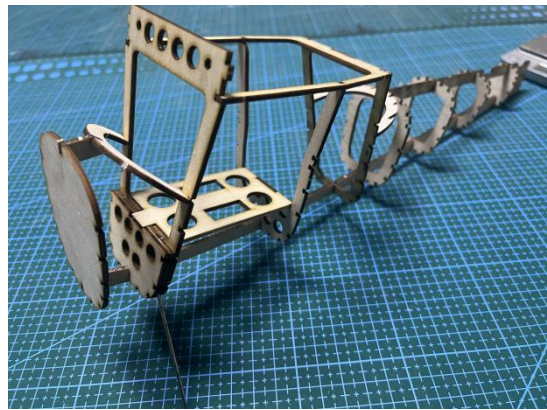

Step11

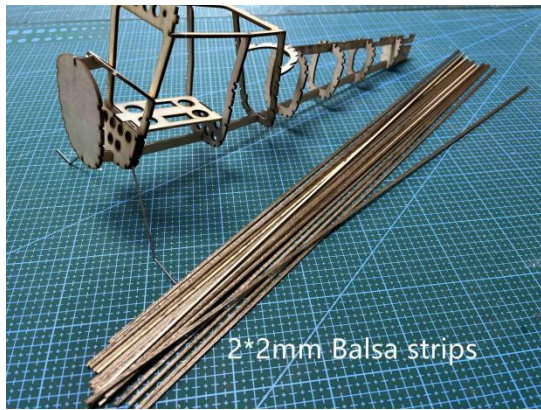

Step12

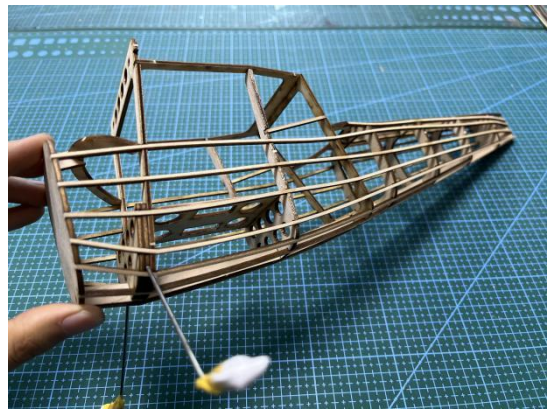

Step13

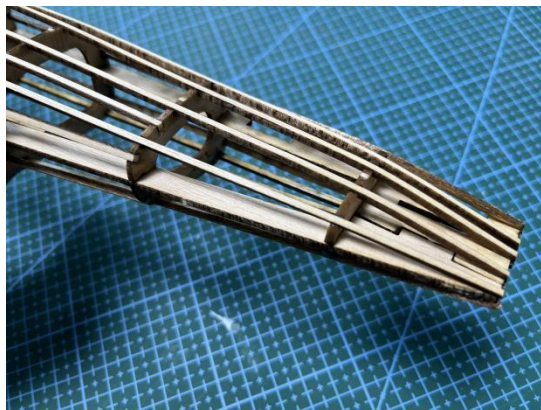

Step14



Step15

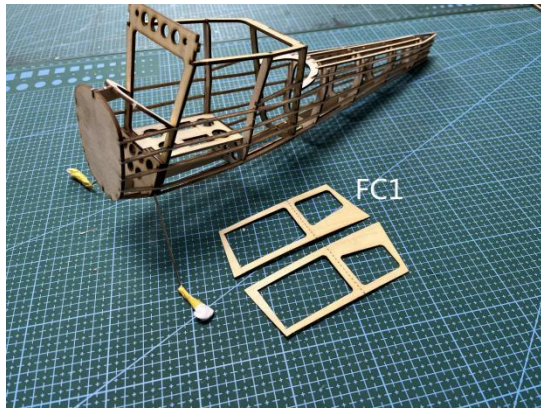

Step16



Step17

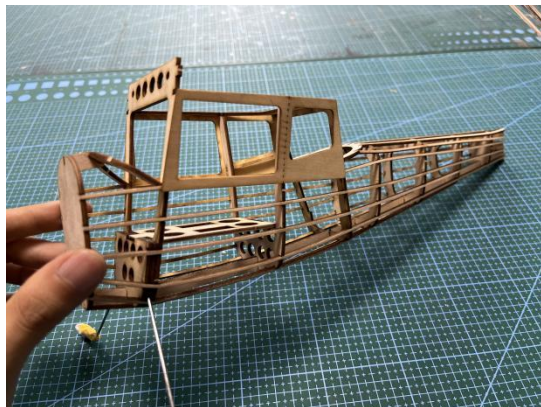

Step18

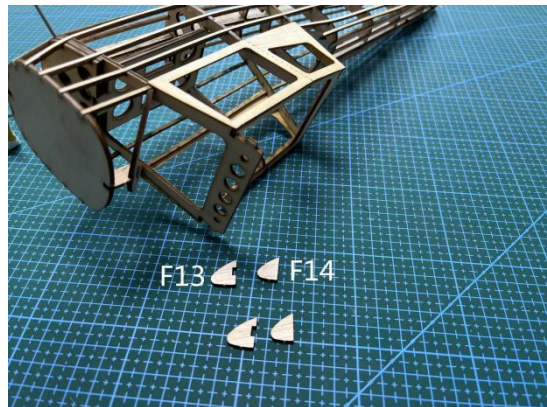

Step19

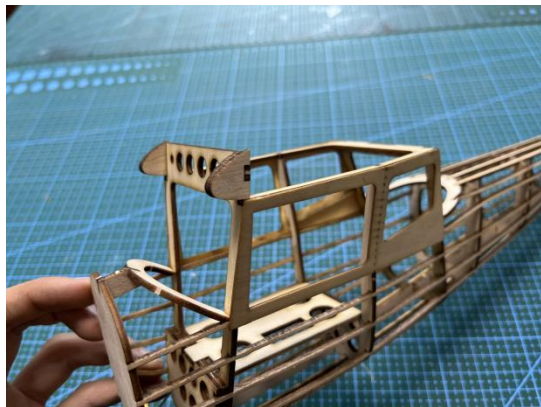

Step20

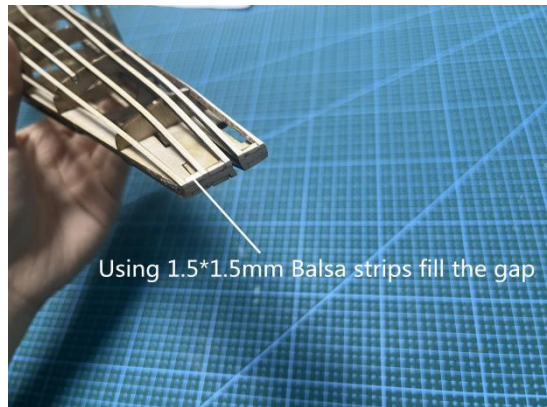

Step21

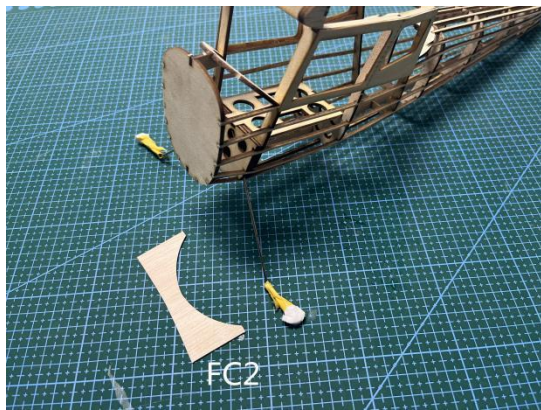

Step22

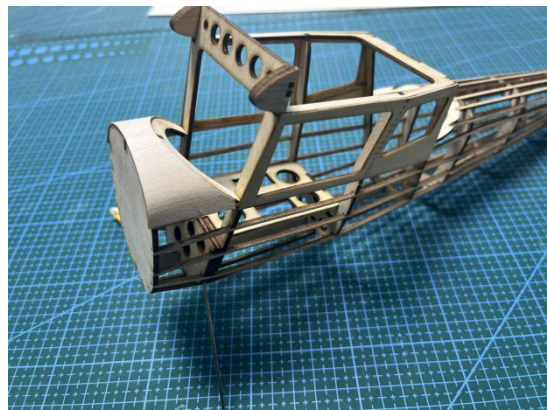

Step23

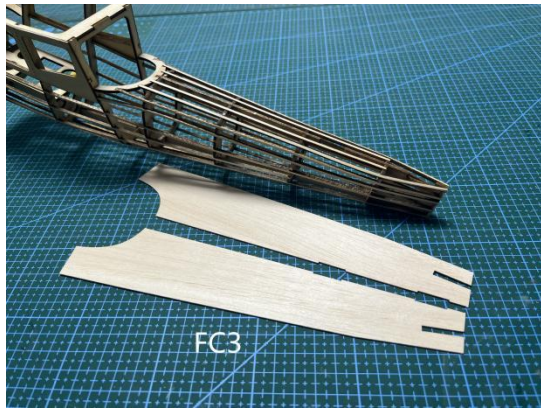

Step24

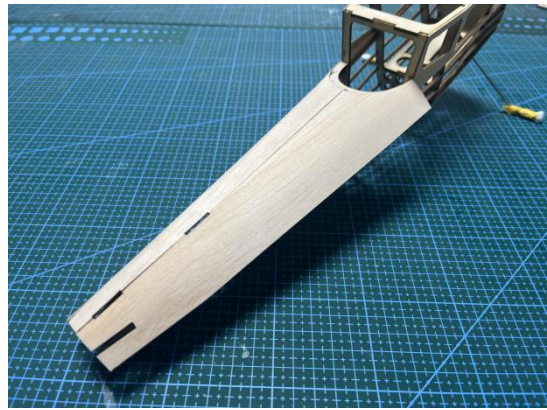

Step25

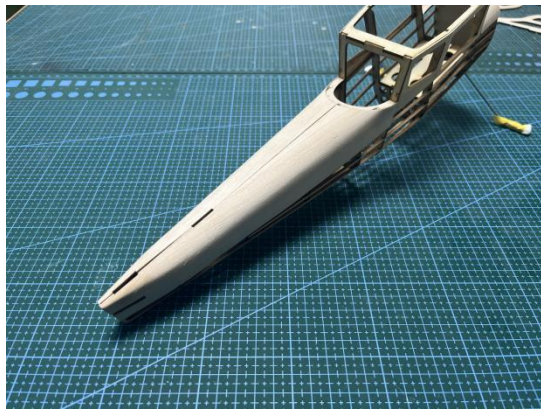

Step26



Step27

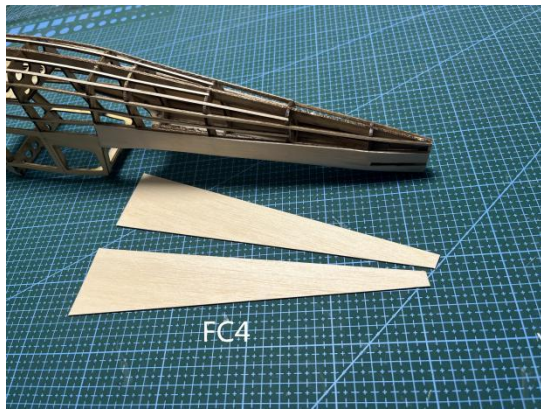

Step28



Step29

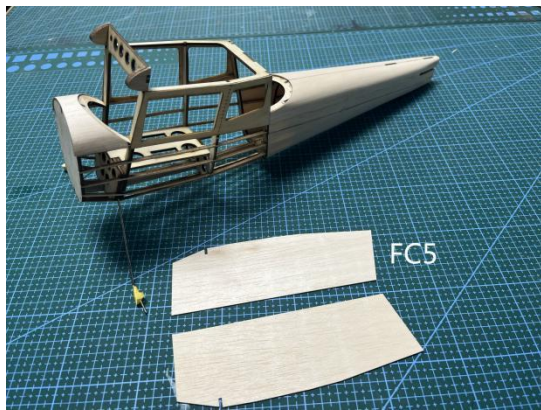

Step30



Step31

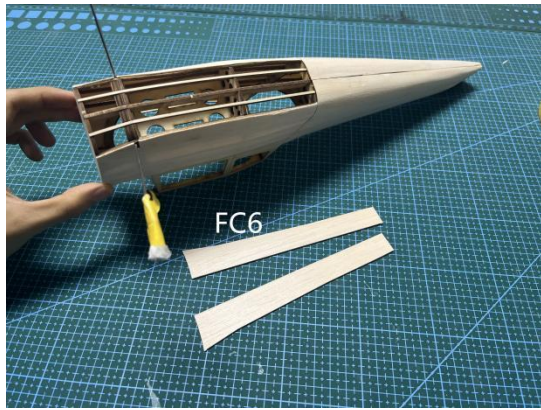

Step32

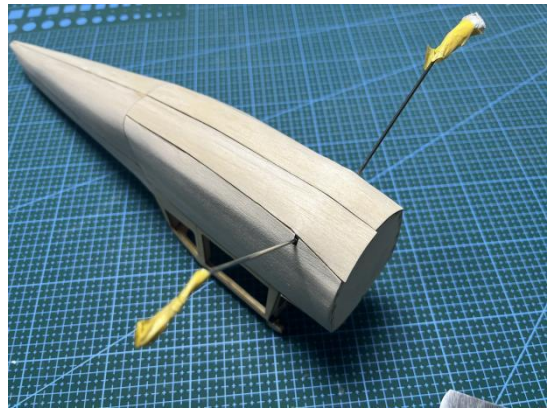

Step33

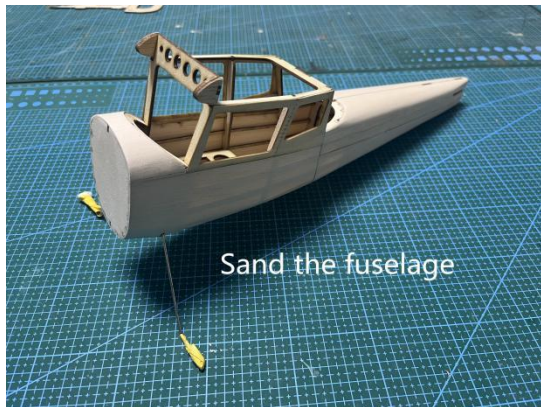

Step34

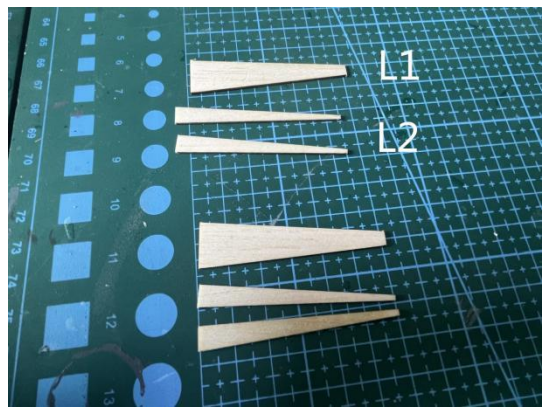

Step35



Step36

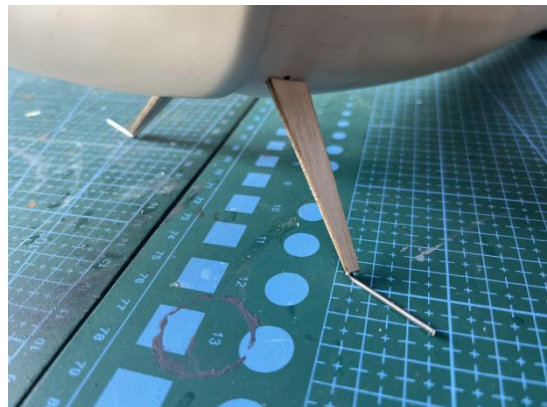

Step37



Step38



# ASSEMBLY-Wing

Step1

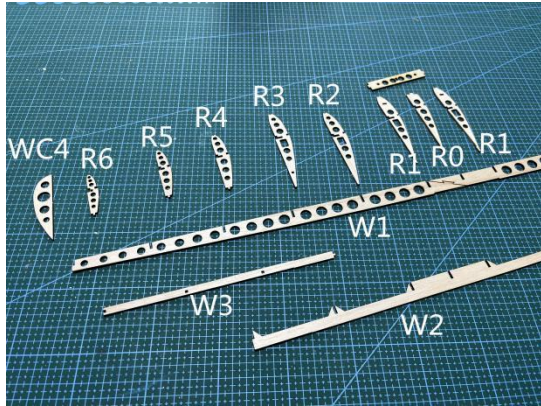

Step2

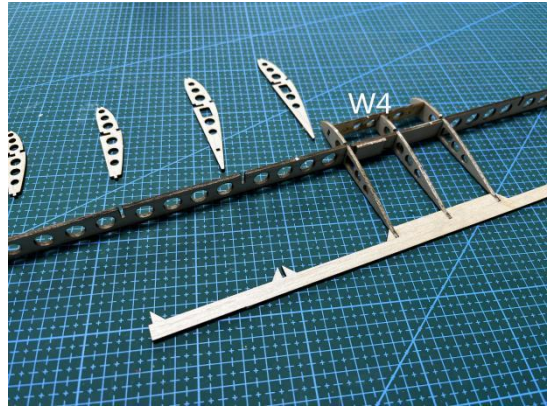

Step3

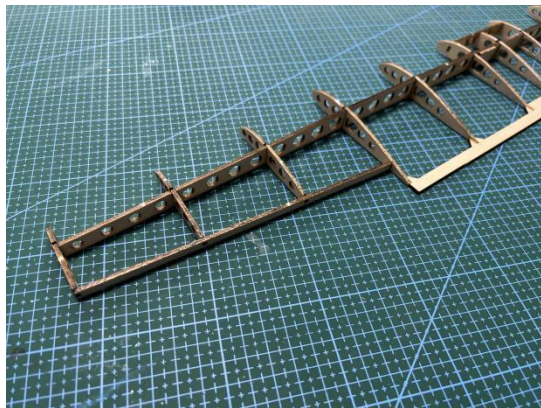

Step4

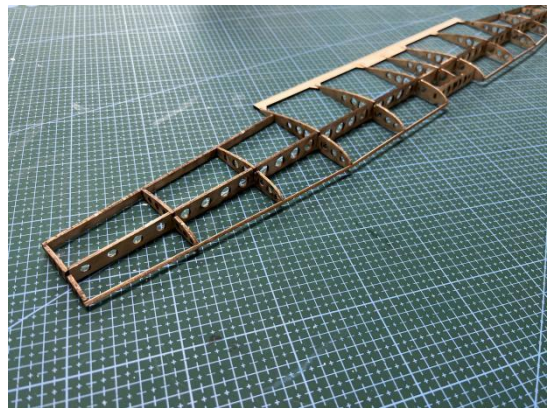

Step5

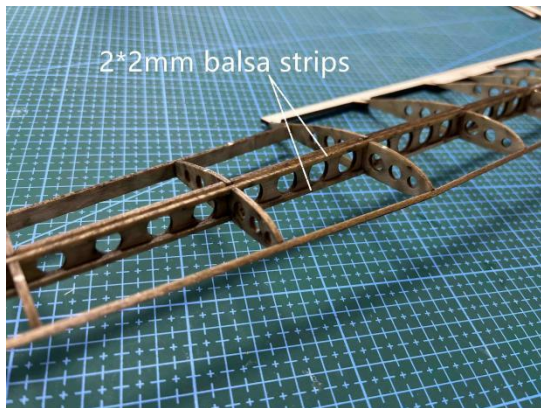

Step6

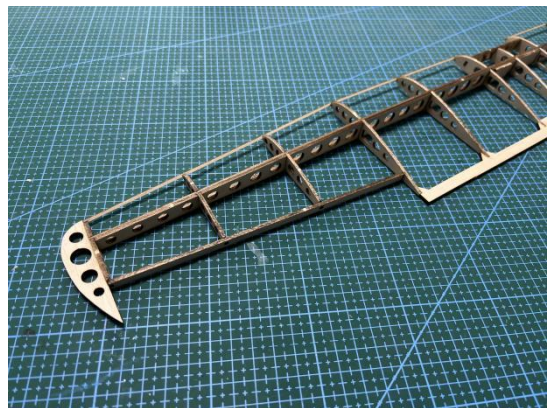

Step7

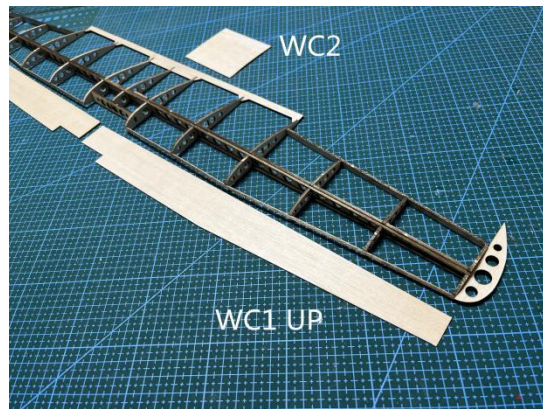

Step8

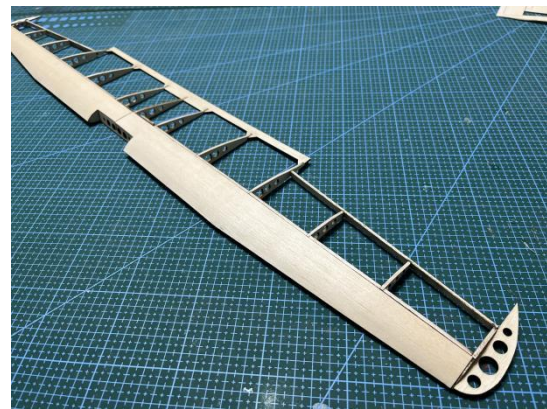

Step9

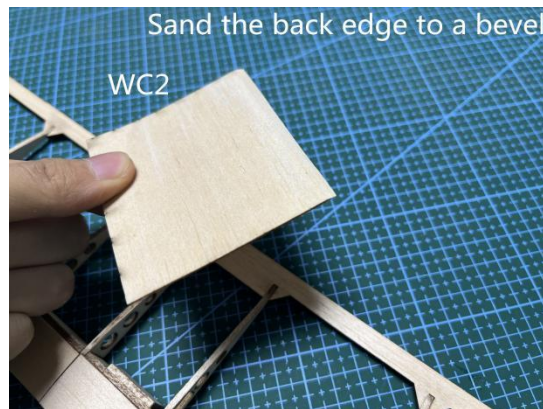

Step10

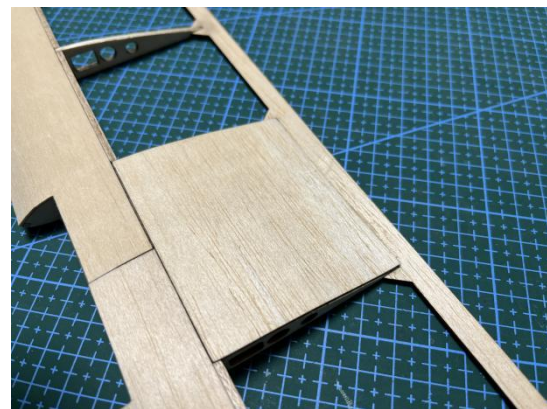

Step11

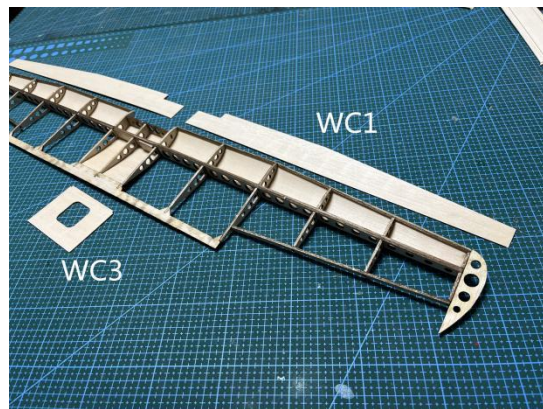

Step12

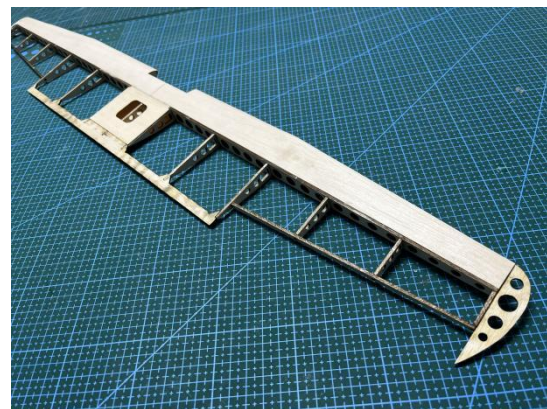

Step13

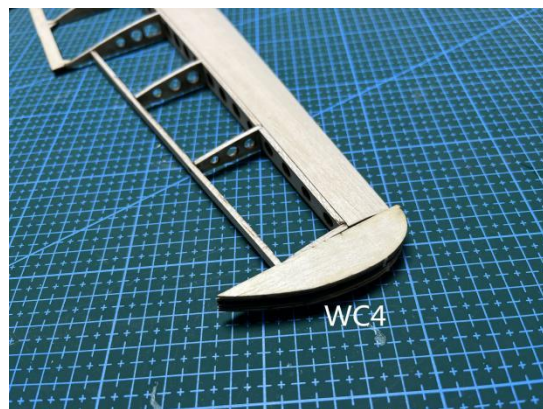

Step14



Step15

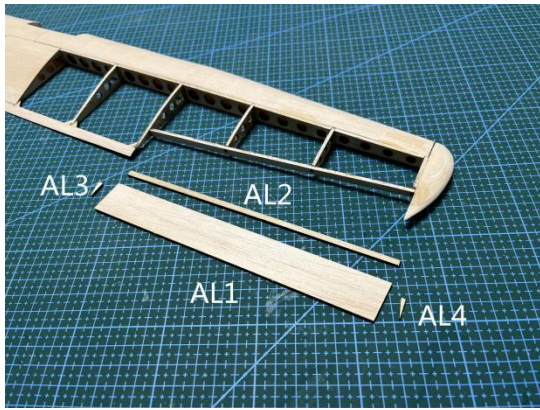

Step16

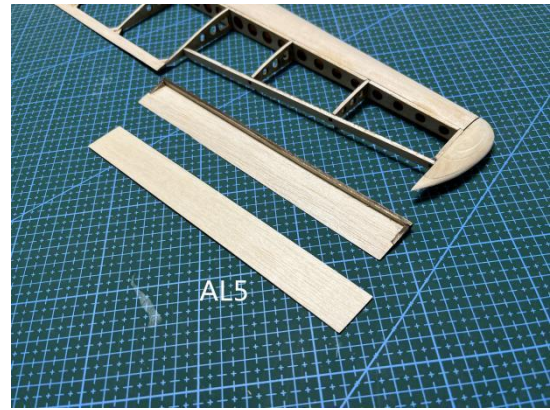

Step17

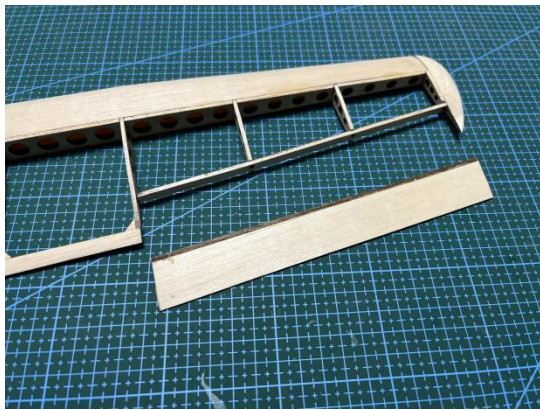

Step18



Step19

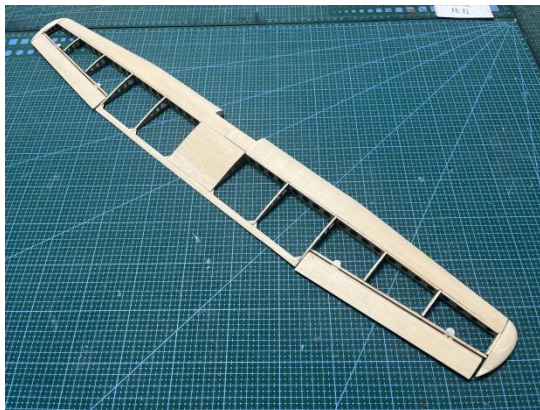

Step20

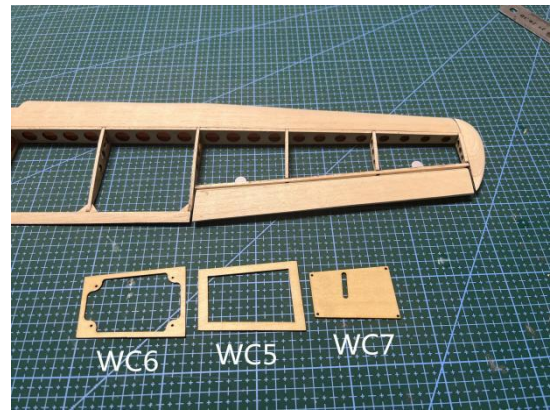

Step21

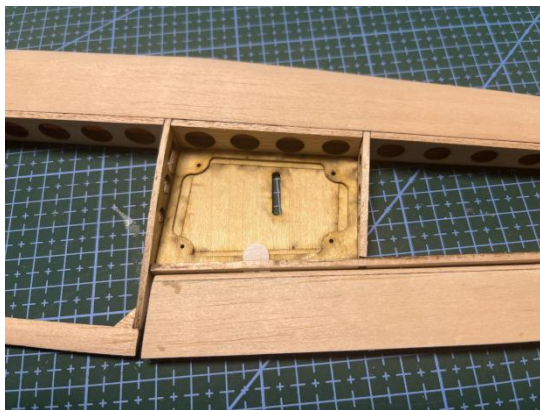

Step22

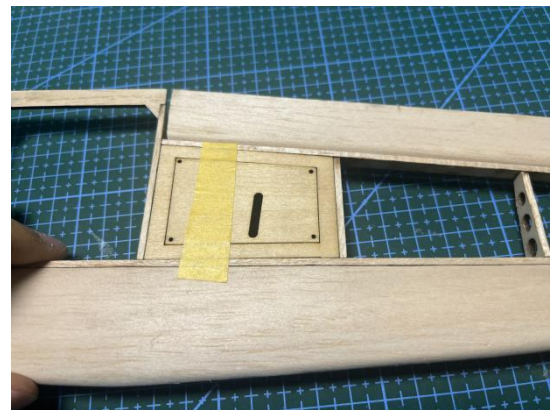

# ASSEMBLY-Electronics

Step1



Step2



Step3

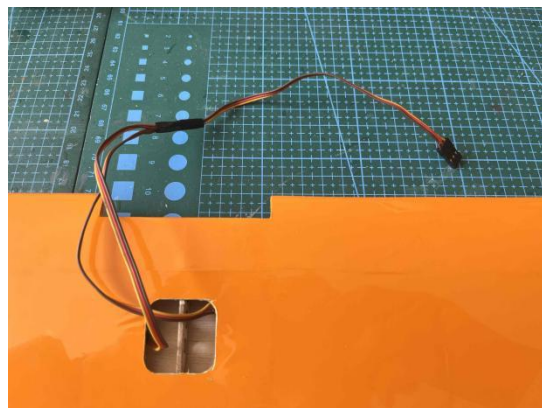

Step4



Step5



Step6

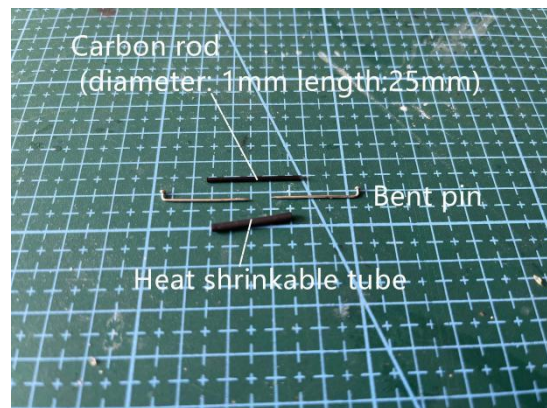

Step7

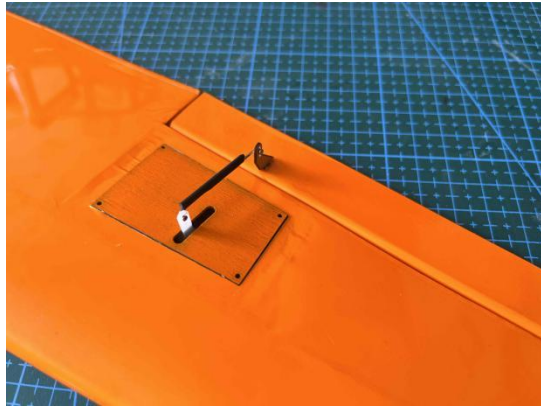

Step8

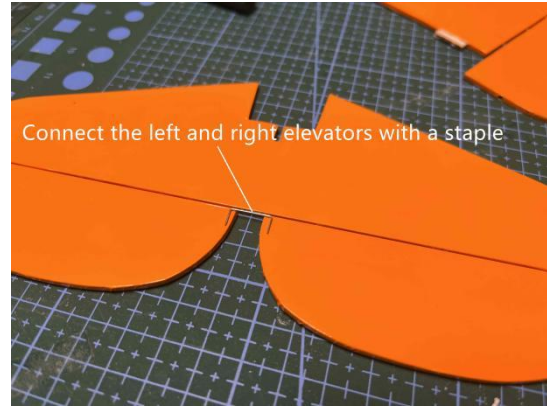

Step9

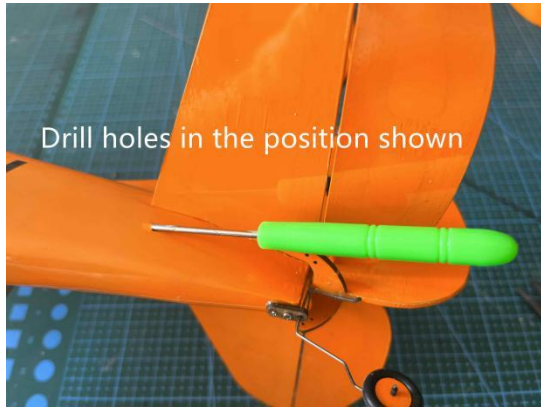

Step10

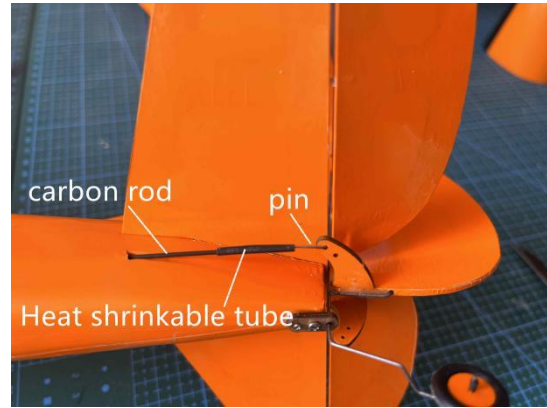

Step11

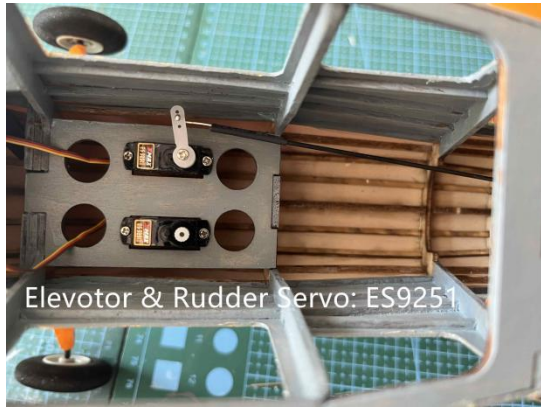

Step12

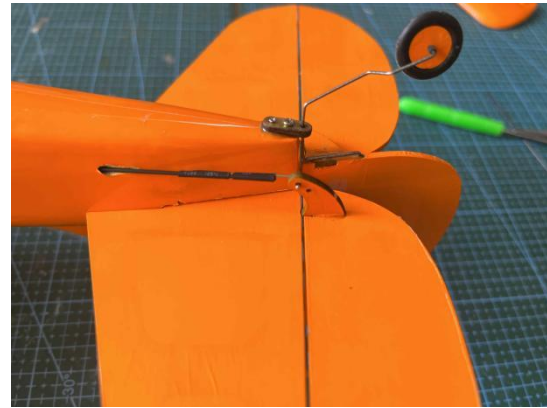

Step13



Step14

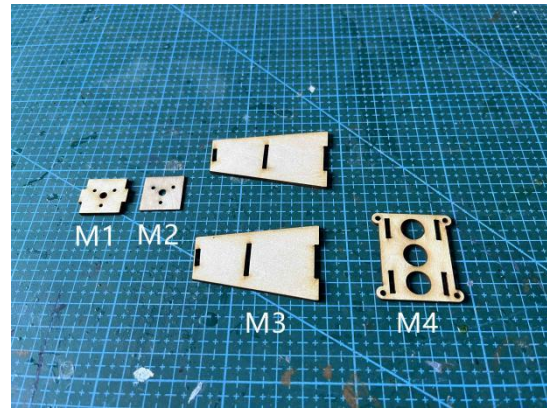

Step15

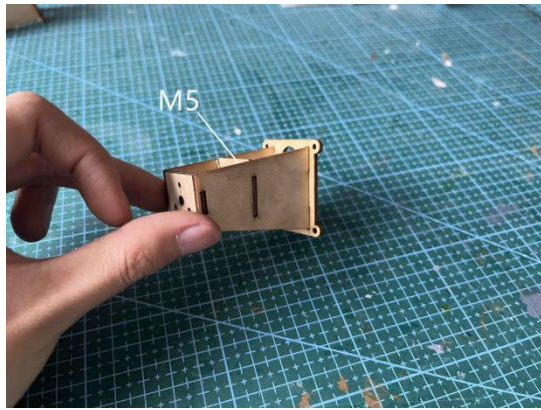

Step16



Step17



Step18



Step19

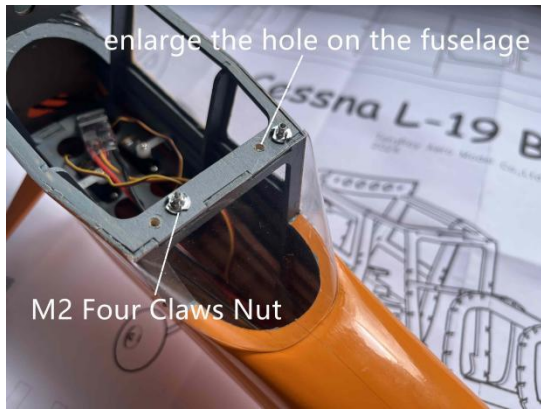

Step20



Step21



**1. CG: 30mm from the leading edge**

<b>2.Control Travel</b>	
ELEVATOR	$\pm 15^\circ$
RUDDER	$\pm 15^\circ$
AILERON	$\pm 20^\circ$

***Thank you!***



**Tony Ray's AeroModel**